

# SF 72 DC

2070

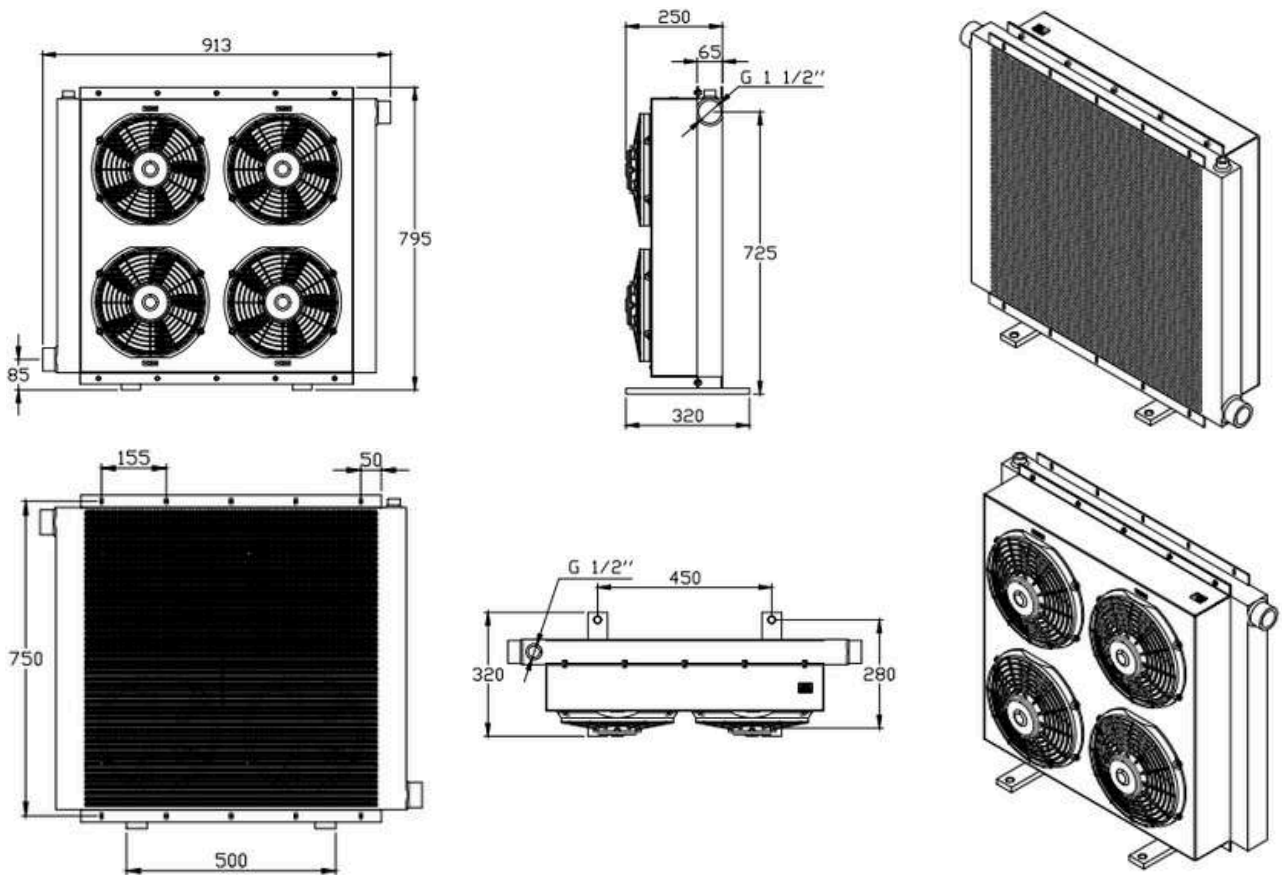

# ISF 72 - 2070 - DC



**2070  
PERFORMANCE DIAGRAM**

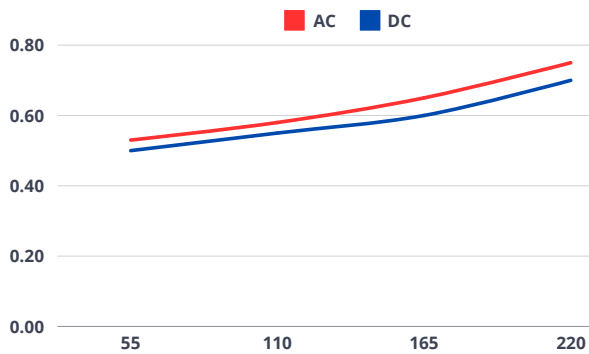

**2070  
PRESSURE DROP**

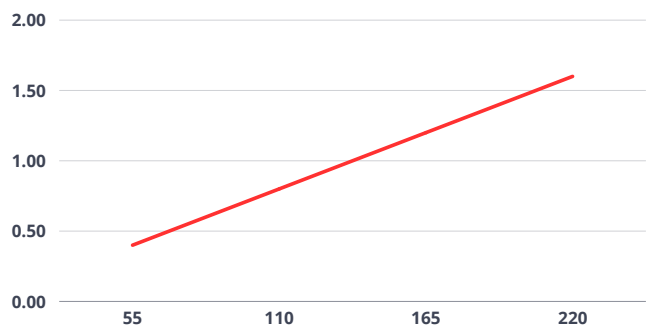

VOLTAGE	OIL FLOW MAX	MAX COOLING CAPACITY	REVOLUTIONS PER MINUTE	FAN Ø	NOISE LEVEL	AIR	WORKING PRESSURE	TEST PRESSURE
V	L/min	kcal/h	r/min	mm	dB	m³/h	bar	bar
12 24	220	30000	2780	280	-	1560	15	24