

SF 21

AC

2015



ISF 21 - 2015 - AC

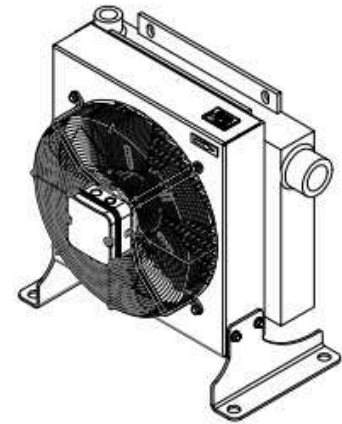
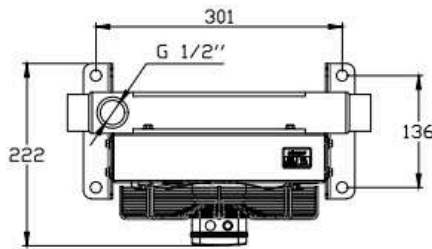
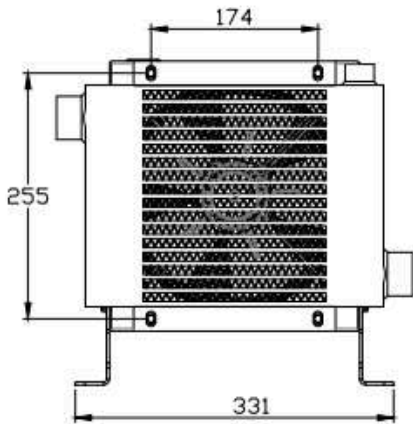
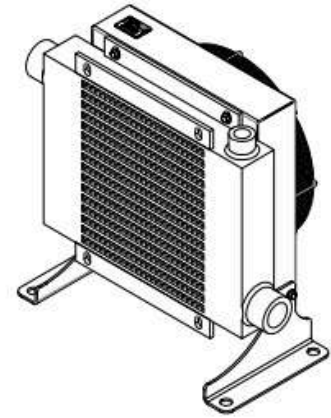
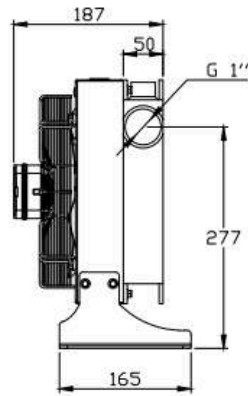
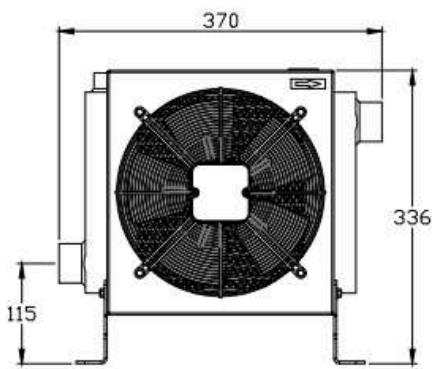

**2015
PERFORMANCE DIAGRAM**

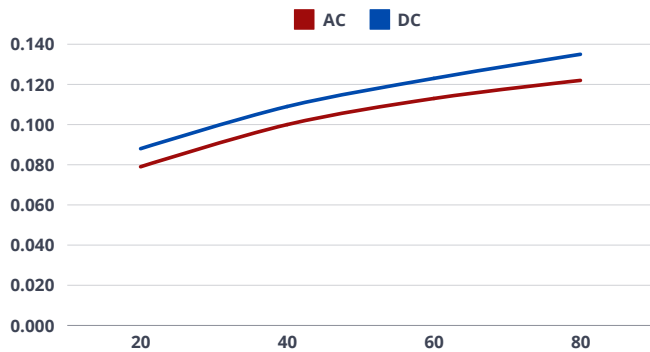

**2015
PRESSURE DROP**

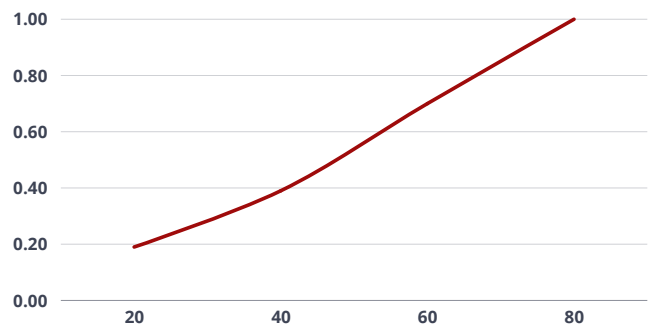

VOLTAGE	OIL FLOW MAX	MAX COOLING CAPACITY	REVOLUTIONS PER MINUTE	FAN Ø	NOISE LEVEL	AIR	WORKING PRESSURE	TEST PRESSURE
V	L/min	kcal/h	r/min	mm	dB	m³/h	bar	bar
220	80	6000	1415	200	53	268	15	24
380			1459					