

SF 24 DC

2020

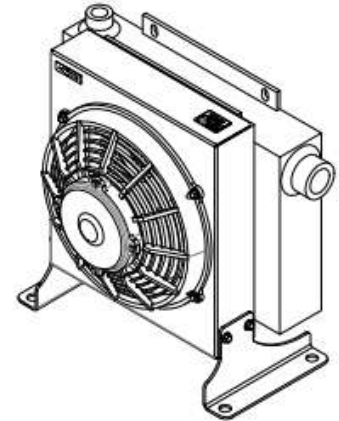

ISF 24 - 2020 - DC

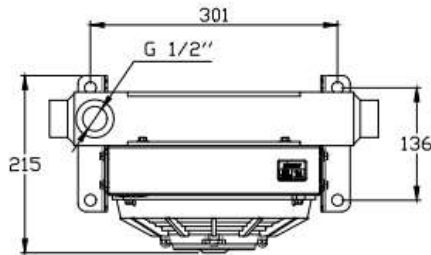
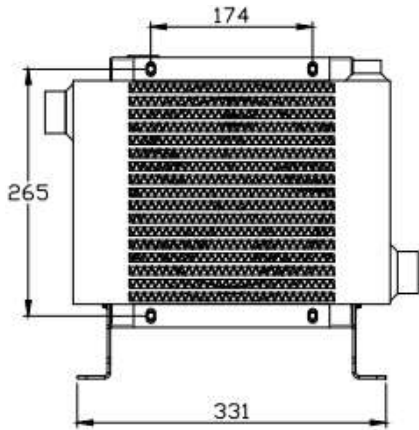
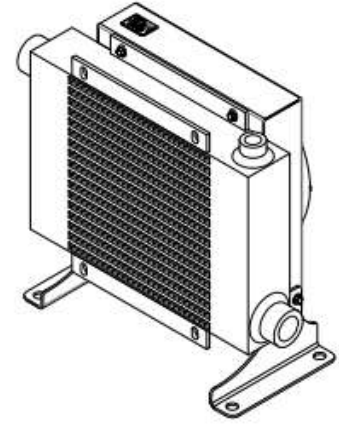
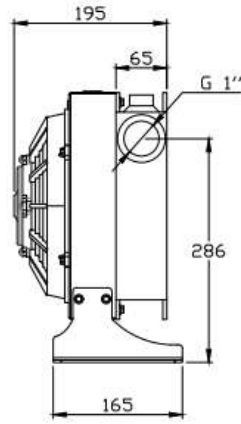
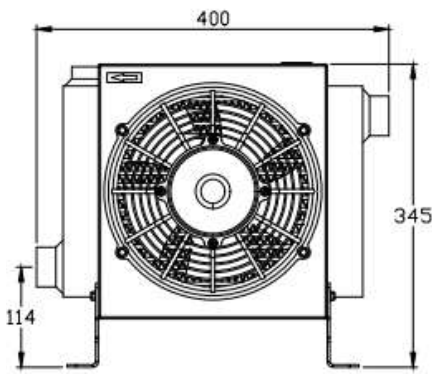

**2020
PERFORMANCE DIAGRAM**

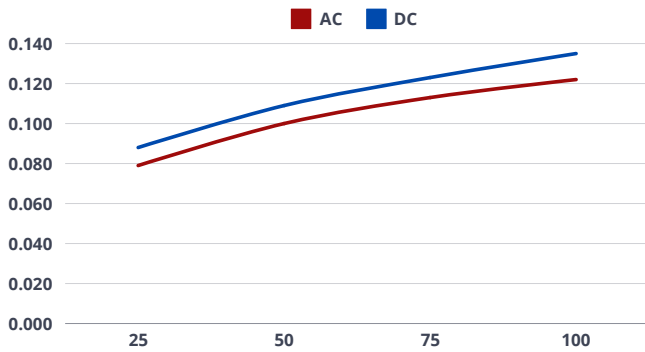

**2020
PRESSURE DROP**

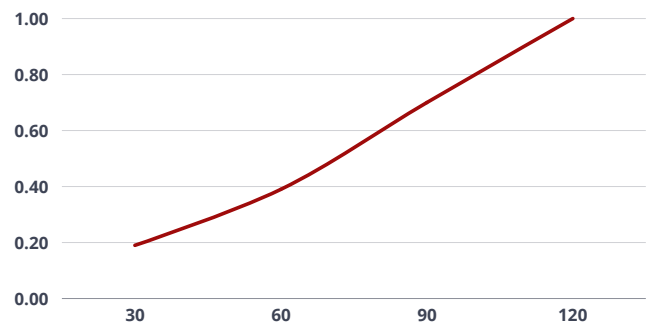

VOLTAGE	OIL FLOW MAX	MAX COOLING CAPACITY	REVOLUTIONS PER MINUTE	FAN Ø	NOISE LEVEL	AIR	WORKING PRESSURE	TEST PRESSURE
V	L/min	kcal/h	r/min	mm	dB	m³/h	bar	bar
12 24	100	7500	3250	225	-	820	15	24