

SF 24 AC 2020

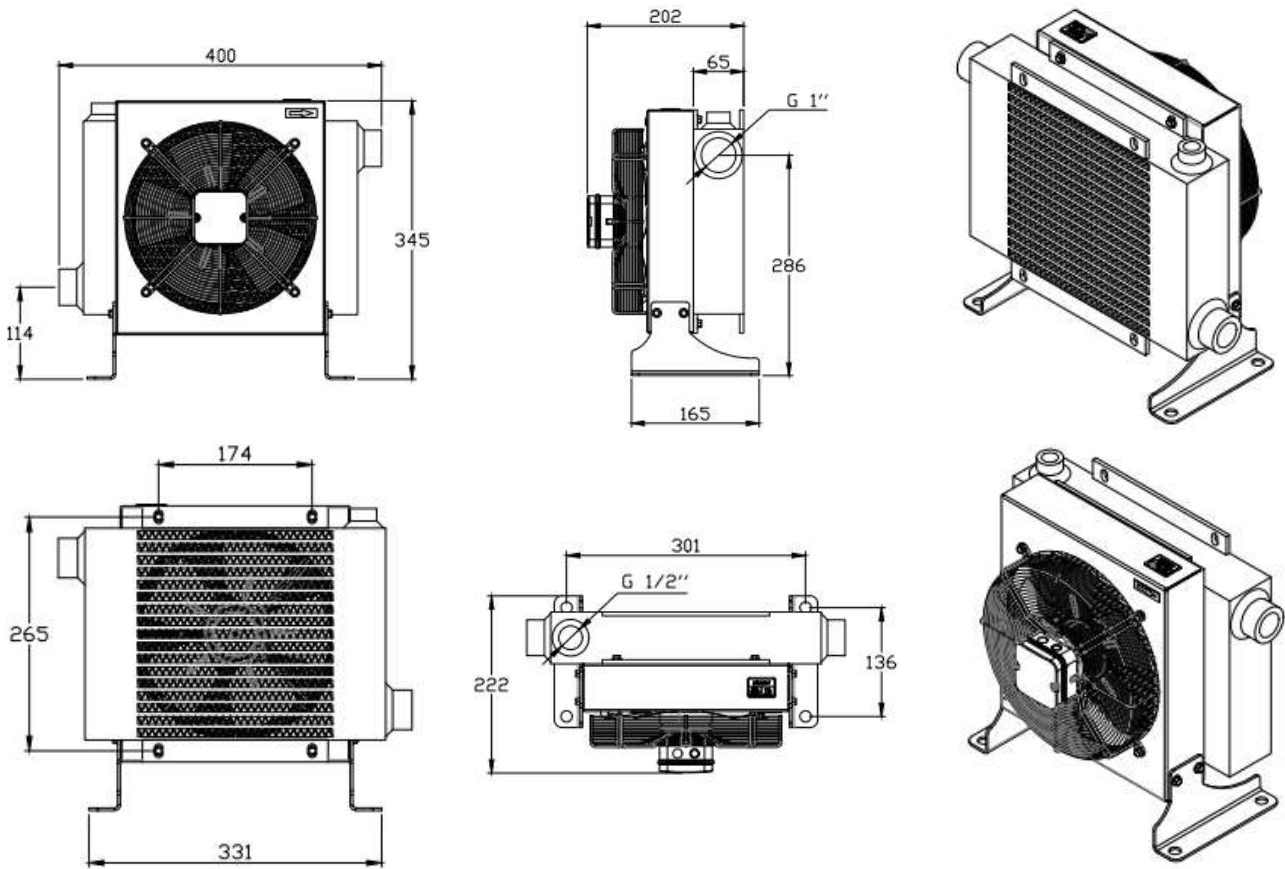

ISF 24 - 2020 - AC



**2020
PERFORMANCE DIAGRAM**

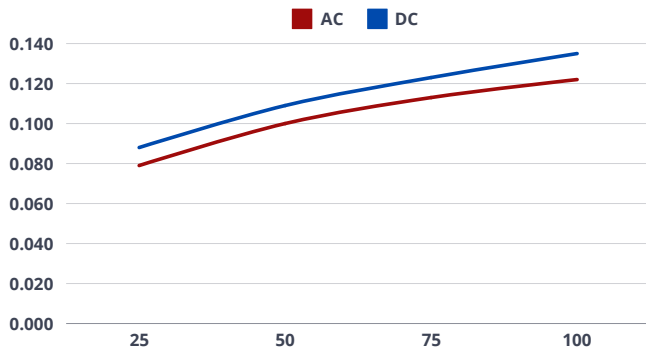

**2020
PRESSURE DROP**

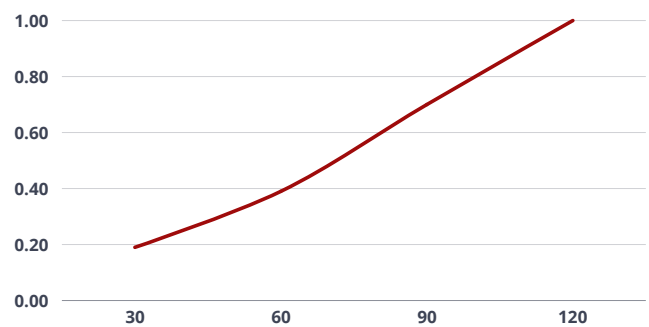

VOLTAGE	OIL FLOW MAX	MAX COOLING CAPACITY	REVOLUTIONS PER MINUTE	FAN Ø	NOISE LEVEL	AIR	WORKING PRESSURE	TEST PRESSURE
V	L/min	kcal/h	r/min	mm	dB	m³/h	bar	bar
220	100	7500	1415	200	53	268	15	24
380			1459					