

SF 14

DC

2010



ISF 14 - 2010 - DC

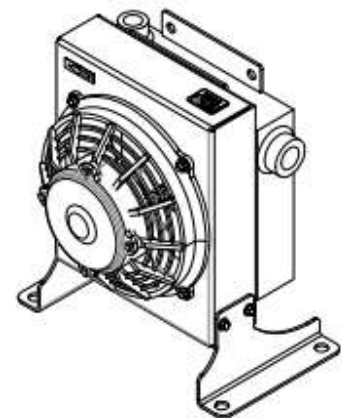
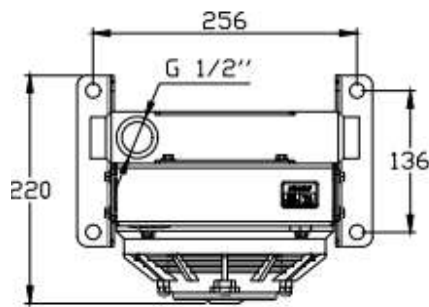
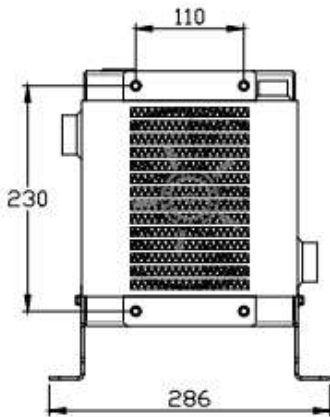
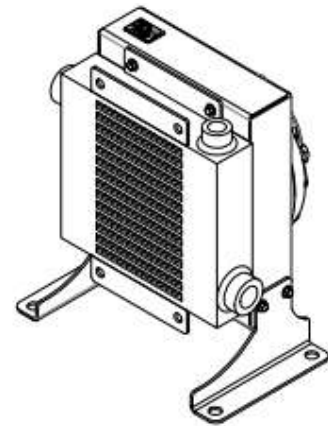
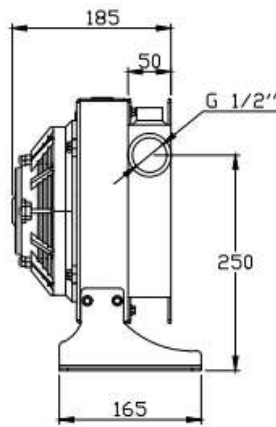
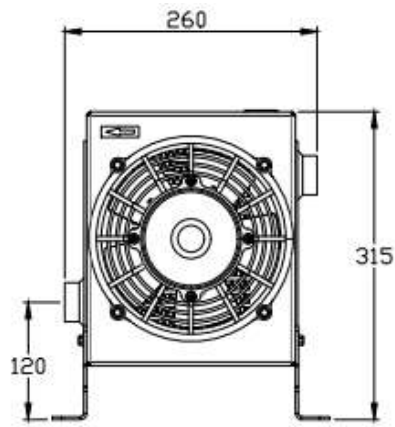

**2010
PERFORMANCE DIAGRAM**

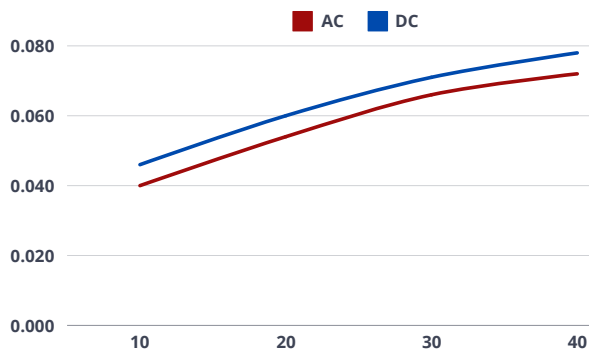

**2010
PRESSURE DROP**

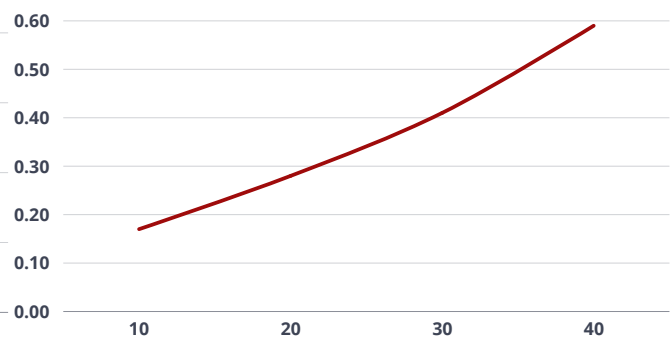

VOLTAGE	OIL FLOW MAX	MAX COOLING CAPACITY	REVOLUTIONS PER MINUTE	FAN Ø	NOISE LEVEL	AIR	WORKING PRESSURE	TEST PRESSURE
V	L/min	kcal/h	r/min	mm	dB	m ³ /h	bar	bar
12 24	40	2500	3250	203	-	700	15	24